



**[BUMPA]**

# Operators manual

**Bumpa 110v  
6m 8m 10m**

# CONTENTS

## Table Of Contents

CONTENTS .....	2
IMPORTANT .....	3
SAFETY RULES .....	4
ELECTROCUTION HAZARD .....	5
<b>Explosion and Fire Hazards</b> .....	6
SETUP HAZARD .....	7
FALL HAZARD.....	8
<b>Bodily Injury Hazard</b> .....	9
<b>Damaged Machine Hazard</b> .....	10
COMPONENT DAMAGE HAZARD .....	10
LEGEND.....	11
CONTROLS .....	12
PRE-OPERATION INSPECTION .....	13
<b>Fundamentals</b> .....	14
<b>Observe and Obey</b> .....	16
<b>Maintenance symbols legend</b> .....	16
MAINTENANCE .....	16
<b>Check main belt tension and tracking:</b> .....	17
<b>Check wheel brakes</b> .....	18
<b>Scheduled Maintenance</b> .....	19
FUNCTION TESTS .....	20
WORKPLACE INSPECTION .....	24
<b>Fundamentals</b> .....	25
OPERATING INSTRUCTIONS.....	26
<b>Fundamentals</b> .....	27
TRANSPORT INSTRUCTIONS.....	32
DECALS .....	33
SPECIFICATIONS .....	35
DIMENSIONS .....	36
OPERATING ANGLES .....	37

# IMPORTANT

---

## Important

Read, understand and obey these safety rules and operating instructions before operating this machine.

Only trained and authorized personnel shall be permitted to operate this machine. This manual should be considered a permanent part of your machine and should remain with the machine at all times. If you have any questions, please call Mace Industries.

---

## Contact us

Mace Industries Limited  
Units 1-3 Macadam Road  
Earlstrees Industrial Estate  
Corby  
NN17 4JN

Web: [www.maceindustries.co.uk](http://www.maceindustries.co.uk)  
Tel: 01536 206 600  
Fax: 01536 206173

# SAFETY RULES



## Danger

---

**Failure to obey the instructions and safety rules in this manual will result in death or serious injury.**

---

Do Not Operate Unless:

You learn and practice the principles of safe machine operation contained in this operator's manual.

**1 Avoid hazardous situations.**

**Know and understand the safety rules before going on to the next section.**

2 Always perform a pre-operation inspection.

3 Always perform function tests prior to use.

4 Inspect the workplace.

5 Only use the machine as it was intended.

You read, understand and obey:

Manufacturer's instructions and safety rules—safety and operator's manuals and machine decals employer's safety rules and worksite regulations applicable to governmental regulations.

# ELECTROCUTION HAZARD

## Electrocution Hazards

This machine is not electrically insulated and will not provide protection from contact with or proximity to electrical current.

Do not operate the machine during lightning or storms.

Do not use the machine as a ground for welding.

Ensure safe routing of power cable to minimise risk of electrocution.



---

Maintain safe distances from electrical power lines and apparatus in accordance with applicable governmental regulations and the following chart:

### Voltage Minimum Safe Phase to Phase Approach Distance

<b>Voltage</b>	<b>Feet</b>	<b>Metres</b>
0 to 300V	Avoid Contact	Avoid contact
300V to 50KV	10	3.05
50KV to 200KV	15	4.60
200KV to 350KV	20	6.10
350KV to 500KV	25	7.62

Allow for machine movement, electrical line sway or sag and beware of strong or gusty winds.

Keep away from the machine if it contacts energized power lines. Personnel must not operate or move the machine until energized power lines are shut off.

Do not operate the machine during lightning or storms .

Do not use the machine as a ground for welding.

Ensure safe routing of power cable to minimise risk of electrocution.

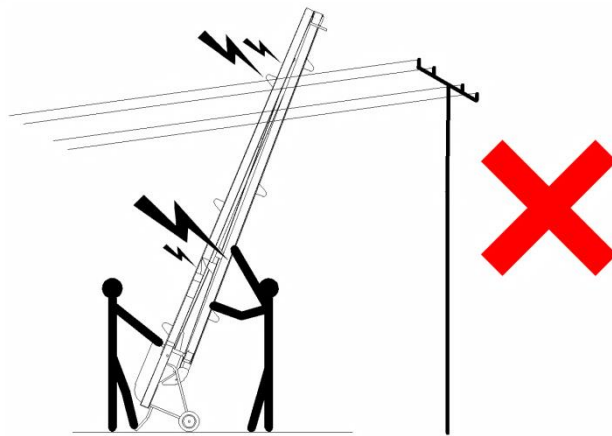

## Explosion and Fire Hazards

Do not operate the machine in hazardous locations or locations where potentially flammable or explosive gases or particles may be present.



# SETUP HAZARD

## Setup Hazards

Check work area for overhead obstructions or other possible hazards.

Do not use the machine whilst under the influence of alcohol or drugs.

Ensure machine is securely fastened at the top and brakes are on before use.

Do not alter or disable machine components that in any way affect safety and stability.

Do not replace items critical to machine stability with items of different weight or specification.

Be aware of ground surface prior to installation.

Do not place ladders or scaffolding against any part of this machine.

Do not use the machine on a moving or mobile surface or vehicle.

Ensure all tyres are in good condition and cotter pins are properly installed.

Do not ride on machine.

Do not alter or disable limit switches or remote handset.

Do not operate the machine in strong or gusty winds.

When erecting the machine, ensure shackles and or ties are secure before lifting.

# FALL HAZARD

## Fall Hazards

Always erect a safety barrier to prevent access through underside of machine. Failure to do so could result in serious injury.



Do not lean over machine while belt is moving.

Do not lean over discharge head of machine whilst loading / unloading.

Ensure loading guides are set central to the load and machine frame.

Do not ride on machine.

Keep the loading platform / scaffold free from debris.

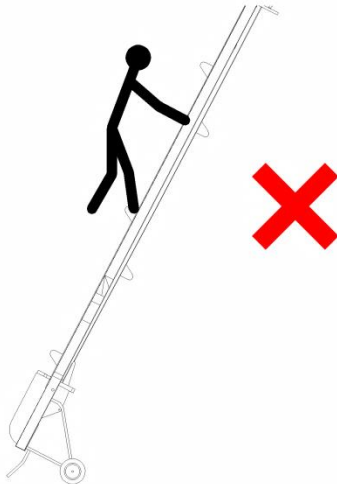



## Bodily Injury Hazard

Use common sense and planning when installing and operating the machine.

Keep hands and limbs away from moving belt.

Always wear correct PPE.



# COMPONENT DAMAGE HAZARD

## Component Damage Hazards

When using a generator, ensure it is fitted with a voltage regulator before use.

Do not over load the machine **80kg MAX** belt load.

Do not over load individual carriers **20kg MAX** per carrier.

Do not use machine as a ground for welding.

---

## Damaged Machine Hazard

Do not use a damaged or malfunctioning machine.

Conduct a thorough pre-operation inspection of the machine and test all functions before each work shift. Immediately tag and remove from service a damaged or malfunctioning machine.

Be sure all maintenance has been performed as specified in this manual and the appropriate Mace Industries service manual.

Be sure all decals are in place and legible

# LEGEND

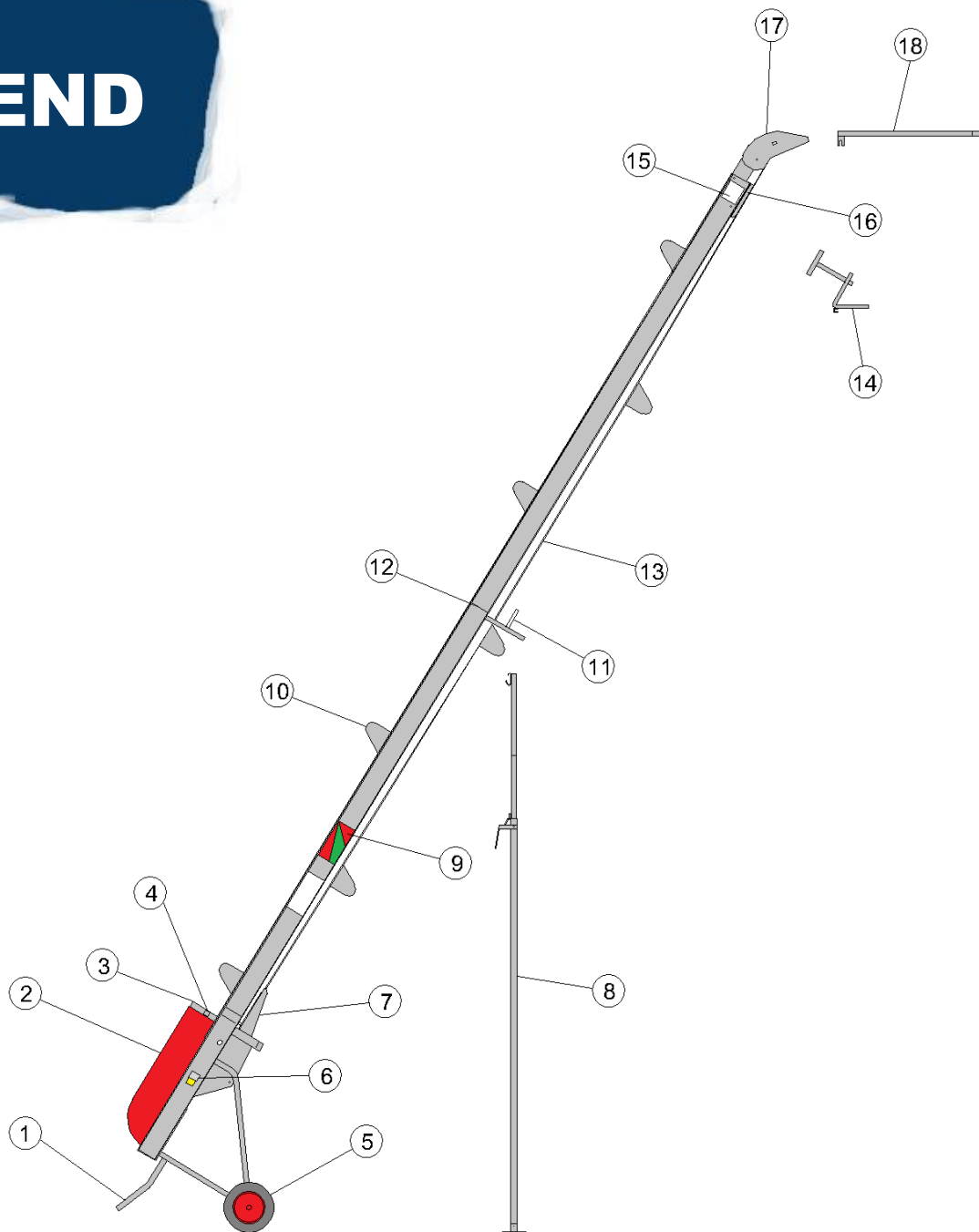

- |                   |                      |                     |
|-------------------|----------------------|---------------------|
| 1. Bogey          | 7. Bottom belt guide | 13. Main Belt       |
| 2. Controls       | 8. 10m Prop          | 14. Scaffold stand  |
| 3. Stop gate      | 9. Angle indicator   | 15. Belt adjustment |
| 4. Loading guides | 10. Belt carrier     | 16. Top belt guide  |
| 5. Wheel          | 11. Machine trestle  | 17. Adjuster head   |
| 6. Power socket   | 12. Hinge            | 18. Shute           |

# CONTROLS

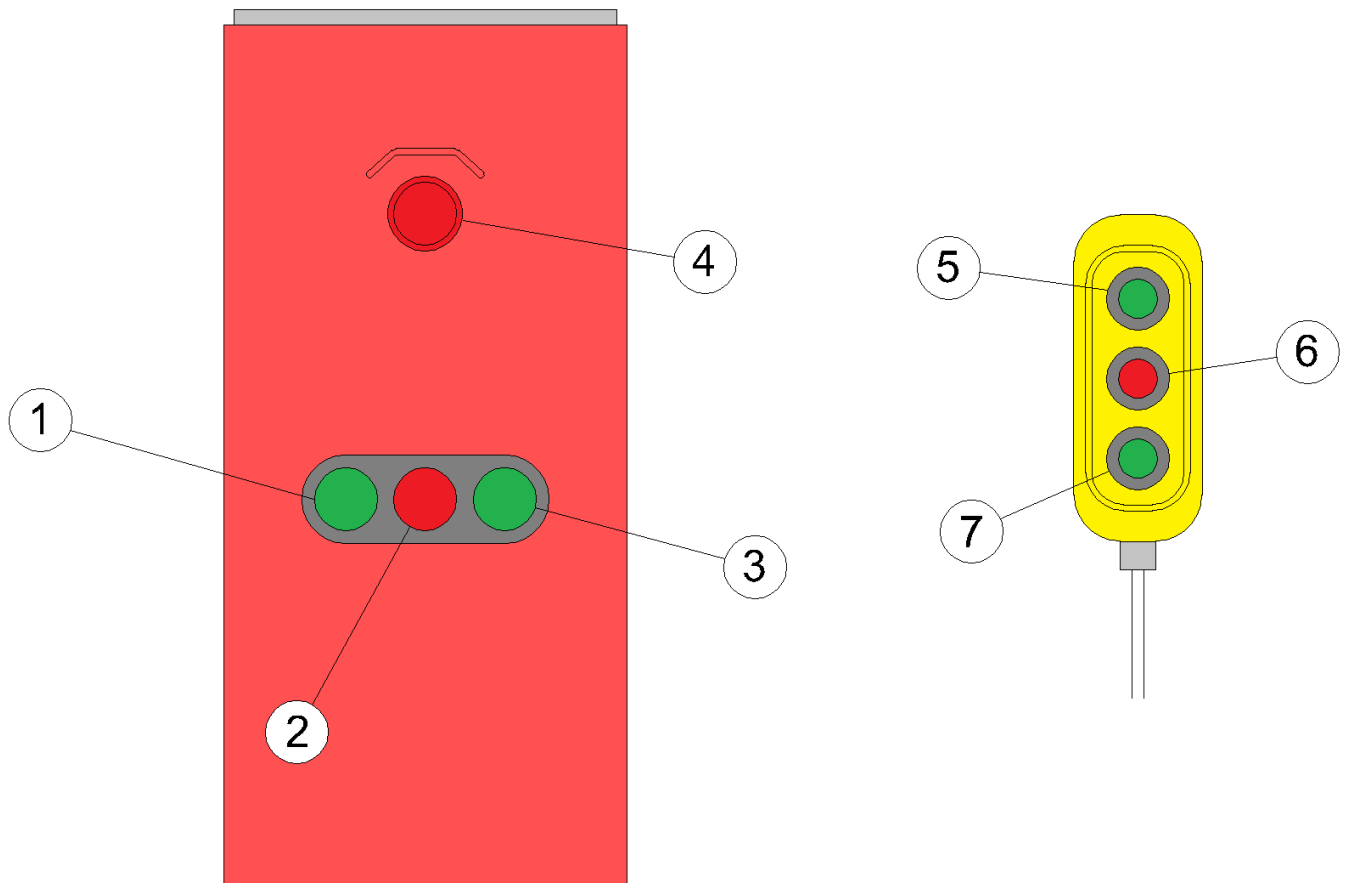

- 1. Reverse
- 2. Stop
- 3. Forward
- 4. Emergency stop

- 5. Forward
- 6. Stop
- 7. Reverse

# PRE-OPERATION INSPECTION



---

## **Do not operate unless:**

You are trained, authorised and have learnt and practiced the principles of safe machine operation contained in this operator's manual.

1 Avoid hazardous situations.

**2 Always perform a pre-operation inspection.**

**Know and understand the pre-operation inspection before going on to the next section.**

3 Always perform function tests prior to use.

4 Inspect the workplace.

5 Only use the machine as it was intended.

## Fundamentals

It is the responsibility of the operator to perform a pre-operation inspection and routine maintenance.

The pre-operation inspection is a visual inspection performed by the operator prior to each work shift.

The inspection is designed to discover if anything is apparently wrong with a machine before the operator performs the function tests.

The pre-operation inspection also serves to determine if routine maintenance procedures are required. Only routine maintenance items specified in this manual may be performed by the operator.

Refer to the list on the next page and check each of the items and locations for modifications, damage or loose or missing parts.

A damaged or modified machine must never be used. If damage or any variation from factory delivered condition is discovered, the machine must be tagged and removed from service.

Repairs to the machine may only be made by a qualified service technician, according to the manufacturer's specifications. After repairs are completed, the operator must perform a pre-operation inspection again before going on to the function tests.

Scheduled maintenance inspections shall be performed by qualified service technicians, according to the manufacturer's specifications.

## Pre Operation Inspection tasks:

Be sure that all decals are legible and in place. See Decals section.

Be sure the main belt is properly tensioned and in good condition.

Be sure the belt carriers are secure and in good condition.

Be sure the correct accessories are present. See parts list.

Check the following components or areas for damage, modifications and improperly installed or missing parts:

- Electrical components
- Limit switch
- Handset
- Wiring
- Stop gate
- Drive motor
- Tyres and wheels
- Brakes
- Power on lights
- Nuts, bolts and other fasteners
- Scaffold clamp

Check entire machine for:

- Cracks in welds or structural components
- Dents or damage to the machine
- Be sure that all structural and other critical components are present and all associated fasteners and pins are in place and properly tightened.

# MAINTENANCE

---

## Observe and Obey

Only routine maintenance items specified in this manual shall be performed by the operator.

Scheduled maintenance inspections shall be completed by qualified service technicians, according to the manufacturer's specifications and the requirements specified in the responsibility's manual.

---

## Maintenance symbols legend

### NOTICE

The following symbols have been used in this manual to help communicate the intent of the instructions. When one or more of the symbols appear at the beginning of a maintenance procedure, it conveys the meaning below.



Indicates tools will be needed to carry out this operation.



## Check main belt tension and tracking:



Maintaining the proper belt tension is essential to good machine performance and service life. Operating the machine with an improper belt tension can damage machine components.

## NOTICE

### Check belt tension whilst power is off.

1. The main belt will only need to be tensioned if it is slipping under load.
2. When the Bumpa is unfolded, measure the distance between the underside of the frame and the belt at the central hinge pivot point.
3. The measurement should be no more than 15cm
4. If measurement is over 15cm – tension as required.

## Check wheel brakes

Maintaining the brakes is an essential aspect of machine maintenance. Whilst erecting a machine the operator depends on the brakes functioning.

# NOTICE

### Check brake function whilst machine is flat on the ground.

1. Move the brake arm back and forth to its extent of travel. Ensure it moves freely.
  - If brake won't move or is stiff grease and retry.
2. Ensure wheel cannot be moved whilst brake is operated.

---

## Check stop gate (Electric only)

Ensuring no contaminants are affecting the operation of the stop gate is essential to ensure proper machine safety functions.

# NOTICE

### Check stop gate function whilst power is off.

1. Remove all visual debris and contaminants from around the stop gate.
2. Press stop gate and listen for a 'click' from the limit switch.
  - If there is no audible 'click' check the threaded tag is aligned correctly on the rear.
3. Repeat 2-3 times to ensure correct function.

## **Scheduled Maintenance**

Maintenance performed quarterly and annually must be completed by a person trained and qualified to perform maintenance on this machine according to the procedures found in the service manual for this machine.

Machines that have been out of service for more than three months must receive the quarterly inspection before they are put back into service.

---

# FUNCTION TESTS



---

## **Do not operate unless:**

You learn and practice the principles of safe machine operation contained in this operator's manual.

1 Avoid hazardous situations.

**2 Always perform function tests prior to operation.**

**Know and understand the function tests before going on to the next section.**

3 Always perform function tests prior to use.

4 Inspect the workplace.

5 Only use the machine as it was intended.

## **Fundamentals**

The function tests are designed to discover any malfunctions before the machine is put into service.

The operator must follow the step-by-step instructions to test all machine functions.

A malfunctioning machine must never be used. If malfunctions are discovered, the machine must be tagged and removed from service.

Repairs to the machine may only be made by a qualified service technician, according to the manufacturer's specifications.

After repairs are completed, the operator must perform a pre-operation inspection and function tests again before putting the machine into service.

## **Function tests:**

1. Select an area that is firm level and free of obstruction.
2. Unfold machine, insert pin through hinge and place end of machine on floor.
3. Plug handset into top of machine.
4. Plug 110v power into input socket.
  - Observe the centre red button on control box. The button should be illuminated.

## **At the ground controls:**

5. Press the emergency stop button.
  - The centre red button should flash indicating a stop circuit function.
6. Press forward and reverse buttons.
  - Belt should not move.
7. Pull out emergency stop button.
  - Red light should return to being permanently illuminated.

## **Test the up and down functions:**

8. Press the forward button.
  - The belt should move forwards.
9. Press the centre stop button.
  - The belt should stop
10. Press the reverse button.
  - The belt should move in reverse.
11. Whilst the belt is moving in reverse press the stop gate.
  - Belt should stop instantly.

**At the handset controls:**

12. Press the forward button.
  - The belt should move forwards.
13. Press the centre stop button.
  - The belt should stop
14. Press the reverse button.
  - The belt should move in reverse.

**If the machine fails any of these function tests, it should be removed from service and repaired.**

---

# WORKPLACE INSPECTION



---

## **Do not operate unless:**

You learn and practice the principles of safe machine operation contained in this operator's manual.

- 1 Avoid hazardous situations.
- 2 Always perform function tests prior to operation.
- 3 Always perform function tests prior to use.

## **4 Inspect the workplace.**

**Know and understand the function tests before going on to the next section.**

- 5 Only use the machine as it was intended.



## Fundamentals

The workplace inspection helps the operator determine if the workplace is suitable for safe machine operation. It should be performed by the operator prior to moving the machine to the workplace.

It is the operator's responsibility to read and remember the workplace hazards, then watch for and avoid them while moving, setting up and operating the machine.

---

## Workplace Inspection

Be aware of and avoid the following hazardous situations:

- Bumps, floor obstructions or debris
- Slopes
- Unstable or slippery surfaces
- Overhead obstructions
- Hazardous locations
- Inadequate surface support to withstand all load forces imposed by the machine
- Wind and weather conditions
- The presence of unauthorized personnel
- Other possible unsafe conditions

# OPERATING INSTRUCTIONS



---

## **Do not operate unless:**

You learn and practice the principles of safe machine operation contained in this operator's manual.

- 1 Avoid hazardous situations.
- 2 Always perform function tests prior to operation.
- 3 Always perform function tests prior to use.
- 4 Inspect the workplace.
- 5 Only use the machine as it was intended.**

## Fundamentals

The Operating Instructions section provides instructions for each aspect of machine operation. It is the operator's responsibility to follow all the safety rules and instructions in the operator's, safety and responsibilities manuals.

This conveyor was designed to transport solid (non-liquid/ non-dangerous) material such as stone, sand, rubble and soil. The material must be loaded responsibly and with skill by the operator as to not cause damage by overloading the conveyor.

Only trained and authorized personnel should be permitted to operate a machine. If more than one operator is expected to use a machine at different times in the same work shift, they must all be qualified operators and are all expected to follow all safety rules and instructions in the operator's safety and responsibilities manuals. That means every new operator should perform a pre-operation inspection, function tests, and a workplace inspection before using the machine.

---

## Operating Instructions:

1. To prevent risk of injury or damage to the machine, first select a suitable level area to open machine. Always check for overhead obstructions i.e. branches, cables etc. prior to opening the machine.
2. Lock wheel brakes on, then with man 1 standing on the hoop at the base of machine to counterbalance weight, (man 1 must remain in position to counterbalance machine throughout opening sequence). Man 2 raises the opposite end until machine bottoms on base hoop. (fig 1)

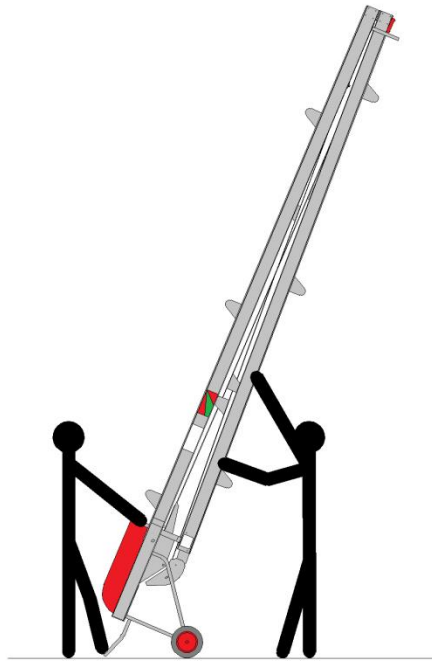

3. Release anti-luce catches and walk top boom approximately 5-6 paces away, then rest head of machine on the ground. (fig 2)

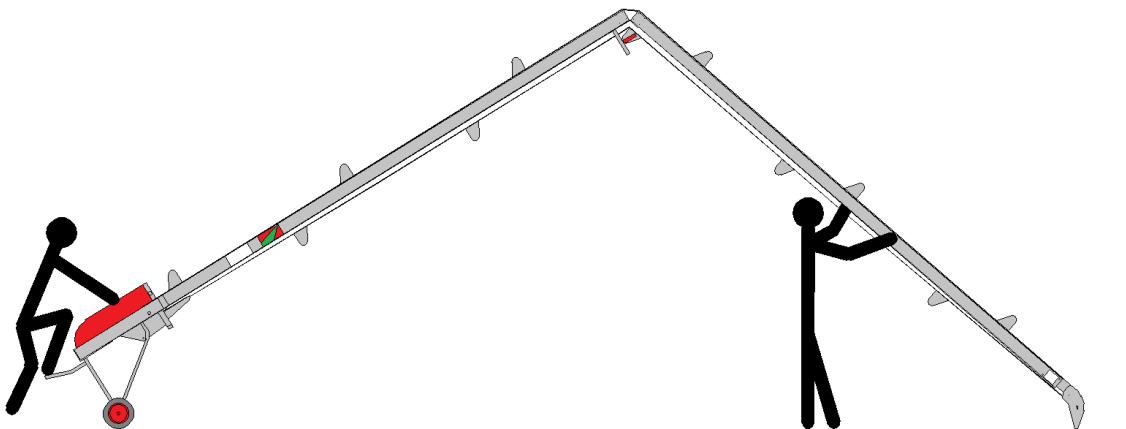

4. With man 2 supporting the machine at centre, (fig 3). Man 1 releases the brakes and walks the base backwards until the machine is fully open.

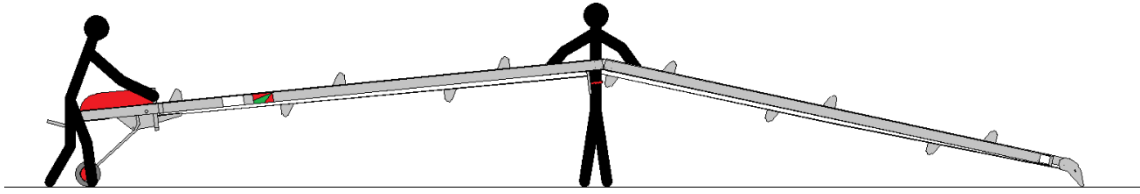

5. Detach clip and remove hinge pin from belt retaining device (RH) then locate pin through the hinge (LH) and replace clip.

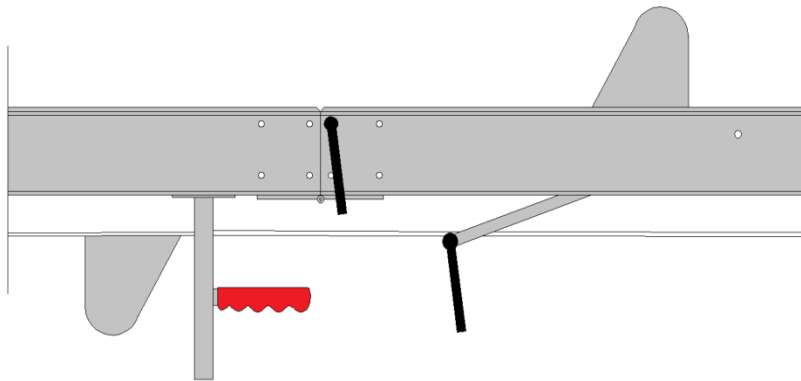

6. The head of the machine is now ready to be raised on to the roof/ scaffold by block and tackle or rope. Ensure lifting device is secure and safe. The base is guided and positioned by man 1. (fig. 4)

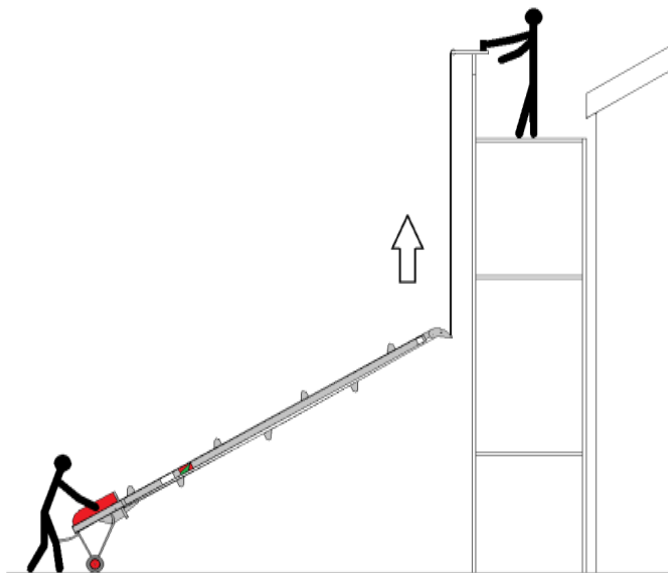

7. Once the machine head is on the scaffold, the stand can be positioned and fixed either to the scaffold boards or roof. (Fig. 5.) Alternatively the head can be clamped to the handrail using the clamp provided. (Fig. 6.) Ensure returning belt carriers clear scaffold before starting machine.

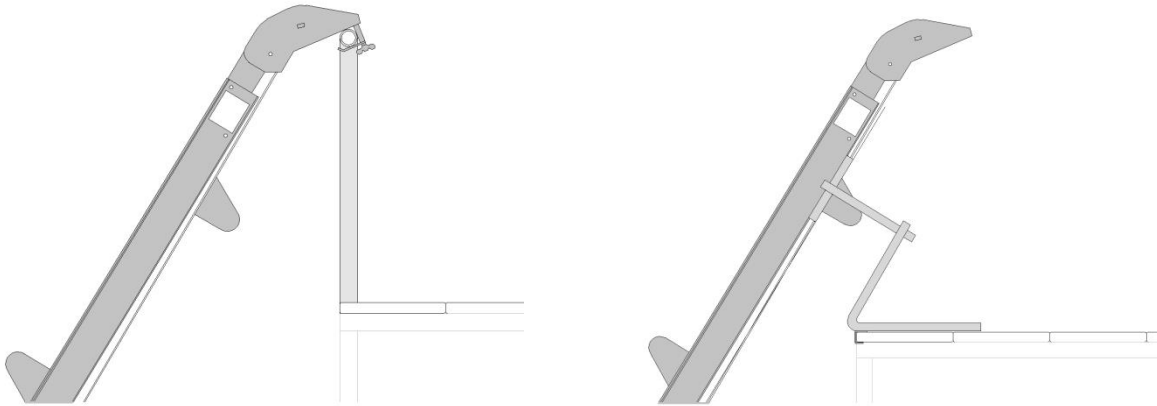

8. With the machine secured on to the scaffold. The delivery chute is now fitted by slotting in to the head lugs. Then rotate and extend as required. (Fig. 7.)

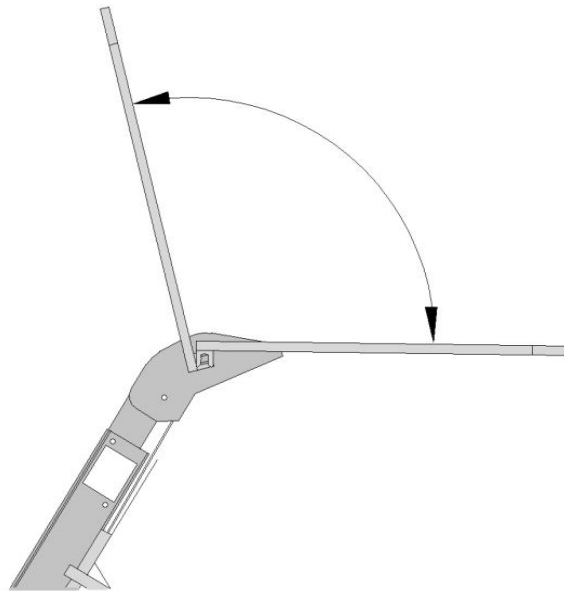

**9.** Fitting centre prop (10 metre machine only). Hook centre prop over prop rest on machine then push up adjust with lever until prop is vertical with machine straight. Prop is self-locking when extended, however lever must be lifted to retract.

**Never operate 10 metre machine without prop in place as machine will be unstable. Periodically check prop positioning during operation.**

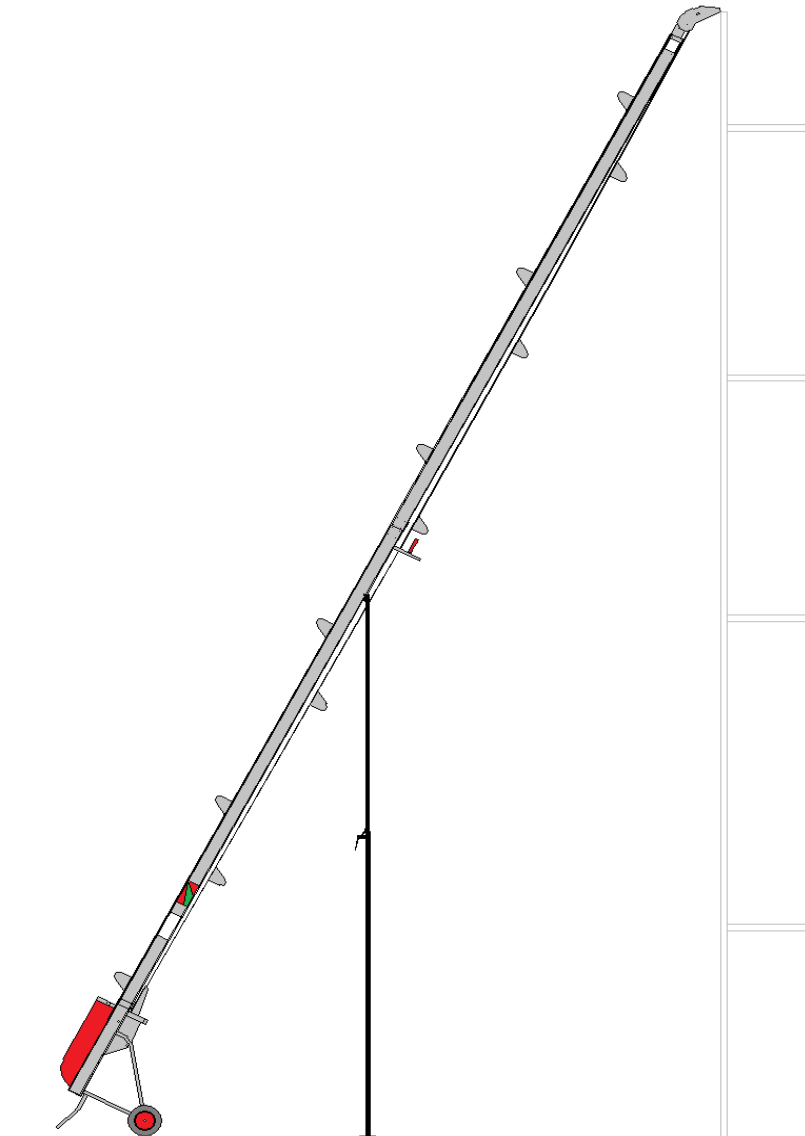

**10.** When machine is erect, place first load onto loading hoop. Centralise loading guides and tighten to minimise un-even loading.

**11.** Plug in handset at head of machine. Plug in power supply. Start pre-operation checks.

# TRANSPORT INSTRUCTIONS



---

## Observe and Obey:

Common sense and planning must be applied to control the movement of the machine when moving it with a forklift.

The transport vehicle must be parked on a level surface.

The machines brakes must remain on whilst being transported.

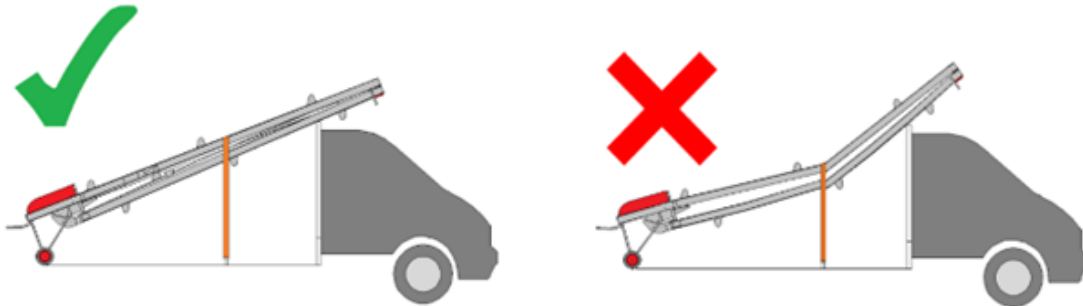

## Securing to Truck or Trailer for Transit:

Always check the machine wheel brakes are on in preparation for transport.

Inspect the entire machine for loose or unsecured items.

## DO NOT OVER TIGHTEN STRAPS.

**Excessive tension of the straps will cause damage to the machine.**



# DECALS

## Decal Inspection:

Use the pictures on the next page to verify that all decals are legible and in place.

Below is a numerical list with quantities and descriptions.

Diagram number	Description	Quantity
1	Operating angle	1
2	Safety instruction	1
3	Main belt adjustment	2
4	Machine opening instruction	1
5	Mace address and Logo	1
6	Serial number and machine type	1
7	Electric safety instruction	1
8	Forward/ Reverse	1
9	Open/ fold machine	1
10	Emergency stop	2
11	Belt stop	1
12	Max sound	1
13	Pinch point	6
14	Bumpa logo	2

**Decal Diagram:**

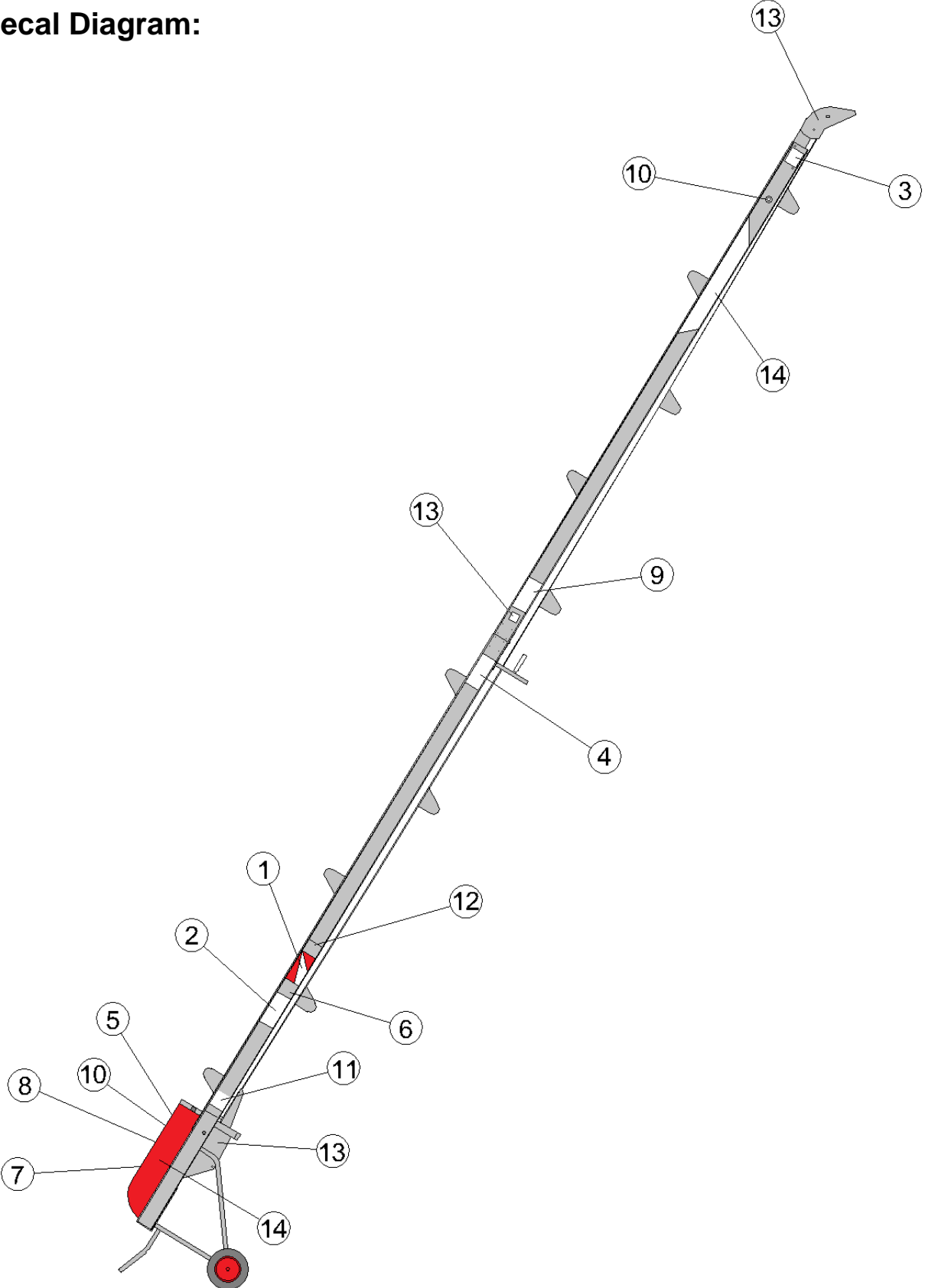

# SPECIFICATIONS

<b>Model</b>	<b>6m</b>	<b>8m</b>	<b>10m</b>
Maximum working height	5.0m	7.0m	9.0m
Machine weight	93kg	103kg	119kg
Maximum payload overall	80kg	80kg	80kg
Maximum carrier payload	20kg	20kg	20kg
Belt speed	20m/min	20m/min	20m/min
Maximum angle	65°	65°	65°
Electric motor	0.75kw	0.75kw	0.75kw
Storage dimensions (flat)	0.85m x 6.3 x 0.6m	0.85m x 4.3m x 0.6m	0.85m x 5.4m x 0.6 m
Noise emissions (A weighted)	>75dB	>75dB	>75dB

# DIMENSIONS

## 6m Bumpa

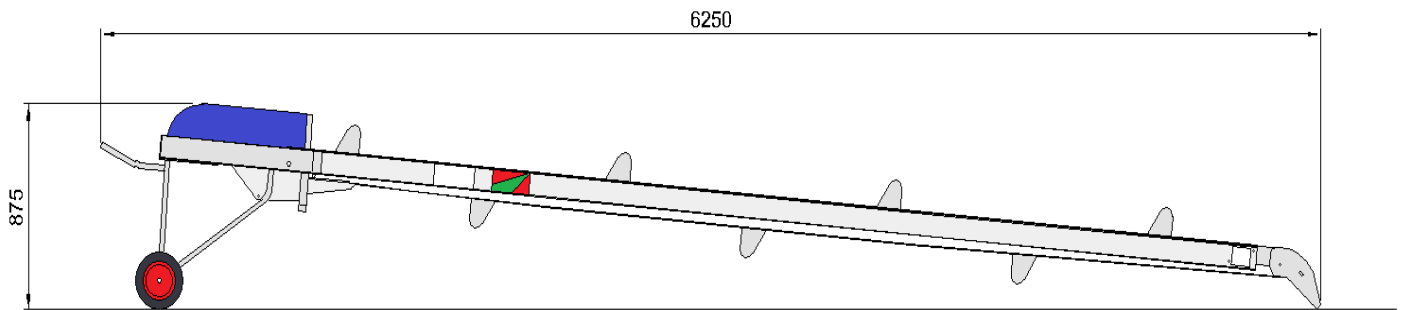

## 8m Bumpa

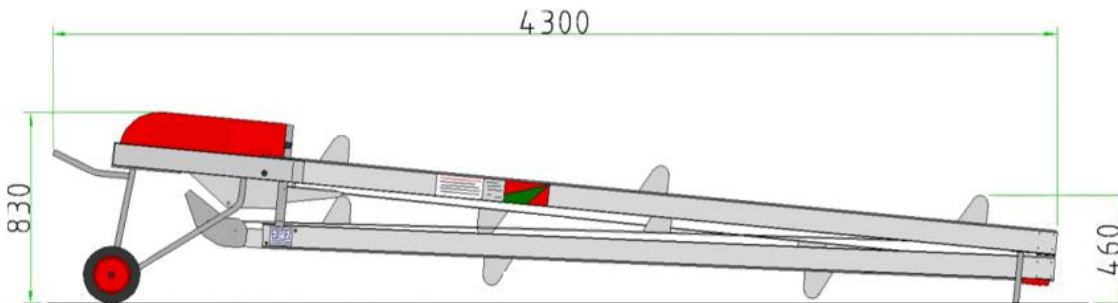

## 10m Bumpa

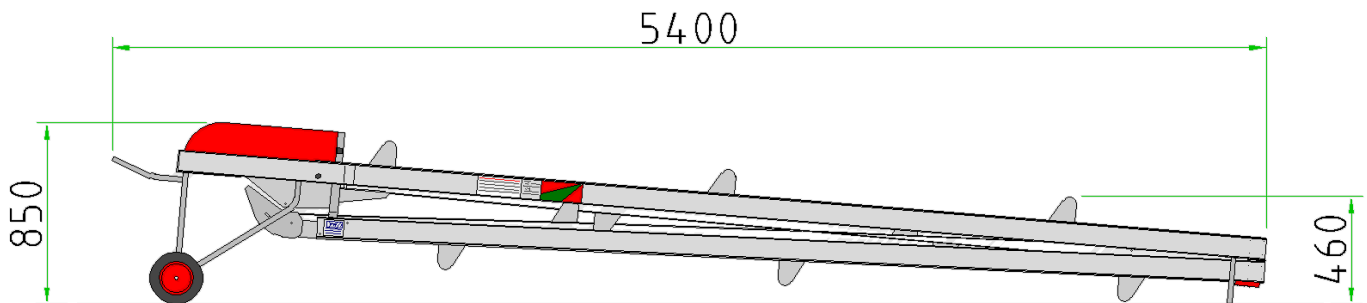

# OPERATING ANGLES

## 6m Bumpa

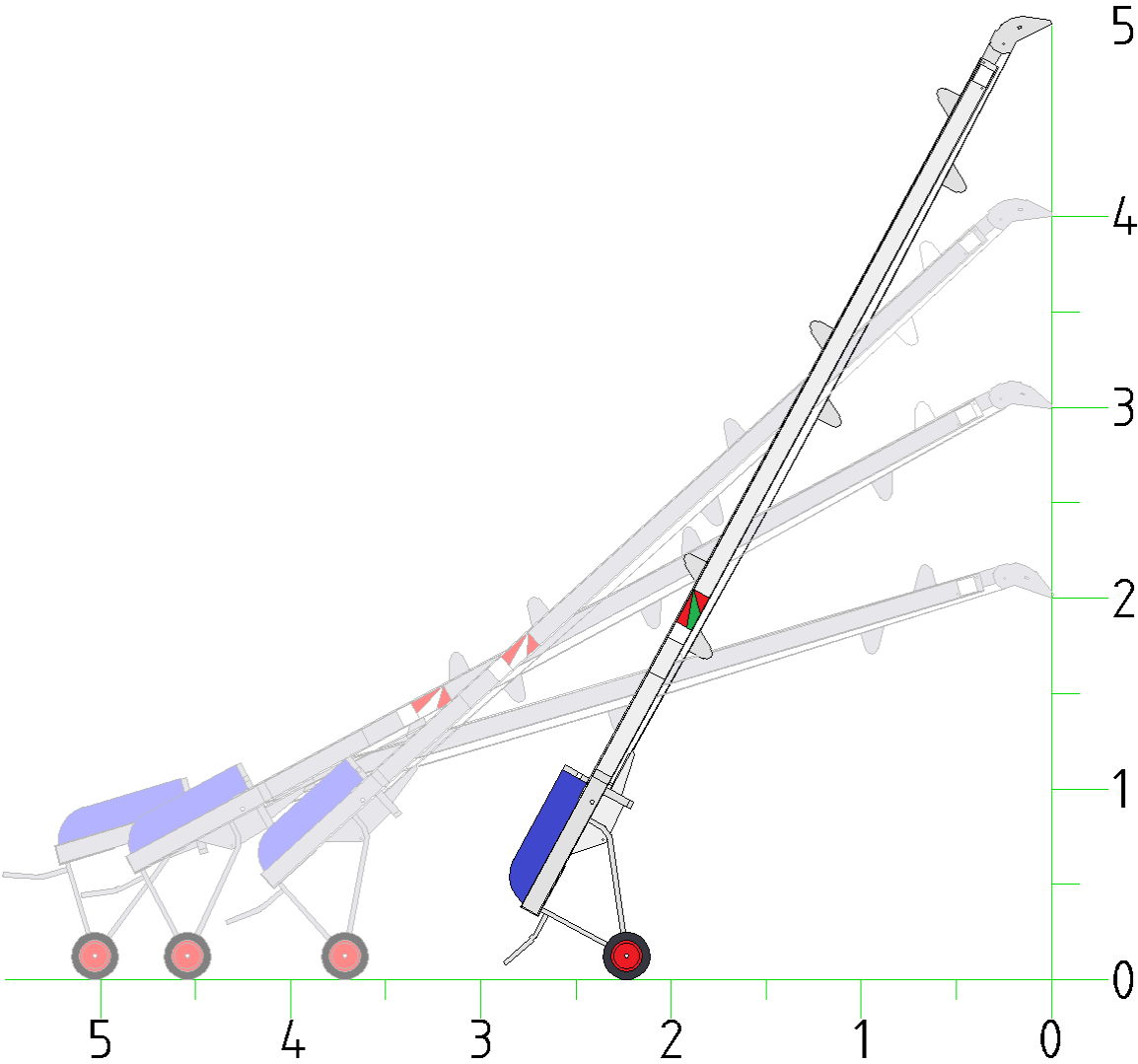

# 8m Bumpa

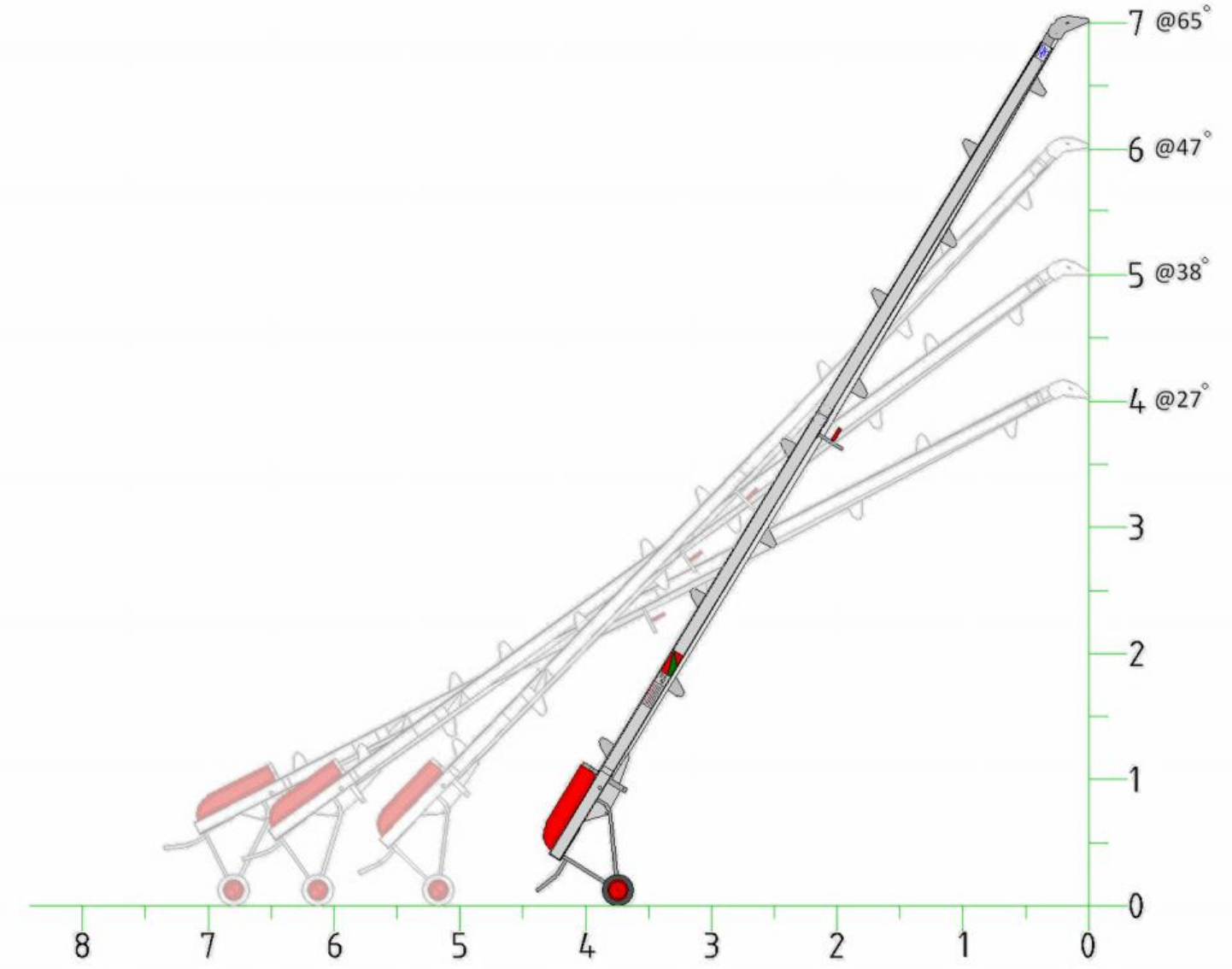

# 10m Bumpa

